

# User Manual

## Smart Logger-A

## Smart Communication Box

In order to prevent improper operation before use, please read this manual carefully.

## Table of Contents

1. Notes on This Manual .....	3
1.1 Scope of Validity .....	3
1.2 Target Group .....	3
1.3 Symbols Used .....	3
1.4 Symbols Explanation .....	3
2. Safety Precautions .....	5
3. Introduction .....	6
3.1 Product Introduction .....	6
3.2 Basic Features .....	6
3.3 Appearance .....	6
3.4 Dimensions .....	7
3.5 Application Scenario .....	7
4. Technical Parameters .....	8
5. Installation .....	9
5.1 Check for Physical Damage .....	9
5.2 Packing List .....	9
5.3 Storage .....	9
5.4 Mounting .....	10
6. Electrical Connection .....	14
6.1 Safety Instructions .....	14
6.2 Port and Indicator Introduction .....	14
6.3 Connect to PV Devices .....	15
6.3.1 Connect to Inverter .....	15
6.3.2 Connect to Multiple Devices .....	17
6.3.3 Connect to Smart Energy Meter .....	18
6.3.4 Connect to Meteo Station .....	18
6.4 Connect to Background .....	19
6.5 Connect to Micro-SIM .....	20
6.6 Cable Routing Requirements .....	20
7. Commissioning .....	21
7.1 Inspection before Commissioning .....	21
7.2 Commissioning Steps .....	21
8. Web Interface .....	22
8.1 Running Requirements .....	22
8.2 Login Steps .....	22
8.3 Configuration Steps .....	22
8.4 Create Site .....	23
9. Grid Dispatch .....	26
9.1 Function Description .....	26
9.2 Interface Description .....	26
9.2.1 Digital Control Interface .....	27
9.2.2 Analog Control Interface .....	28
9.2.3 DRM Control Interface .....	28

10. Maintenance .....	29
10.1 Safety Instructions .....	29
10.2 Routine Maintenance .....	29

# 1. Notes on This Manual

## 1.1 Scope of Validity

This manual describes the assembly, installation, commissioning, maintenance and troubleshooting of the following model(s) of Fox ESS products:





**Smart Logger-A**

## 1.2 Target Group

This manual is for qualified electricians. The tasks described in this manual only can be performed by qualified electricians.



## 1.3 Symbols Used

The following types of safety instructions and general information appear in this document as described below:

	<b>Danger!</b> “Danger” indicates a hazardous situation which, if not avoided, will result in death or serious injury.
	<b>Warning!</b> “Warning” indicates a hazardous situation which, if not avoided, could result in death or serious injury.
	<b>Caution!</b> “Caution” indicates a hazardous situation which, if not avoided, could result in minor or moderate injury.
	<b>Note!</b> “Note” provides important tips and guidance.

## 1.4 Symbols Explanation

This section explains the symbols shown on the Smart Logger-A and on the label:

Symbols	Explanation
	CE mark. The Smart Logger-A complies with the requirements of the applicable CE guidelines.
	Read the manual.
	Product should not be disposed as household waste.



This mark indicates that the product meets EU environment protection certification requirements.

## 2. Safety Precautions

Smart Logger-A is designed and tested in accordance with international safety requirements. However, certain safety precautions must be taken into account when installing and operating the Smart Logger-A. The installer must read and follow all instructions, cautions, and warnings in this installation manual.

- In case of fire, evacuate from the building or product area and call the fire alarm. Re-entry into the burning area is strictly prohibited under any circumstances.
- All operations including transport, installation, start-up, and maintenance, must be carried out by qualified, trained personnel and shall comply with local wiring rules and regulations.
- Do not operate the product and cables (including but not limited to moving the product, installing the product, operating the product and cables, powering up the product, maintaining the product, and working at heights) in harsh weather conditions such as lightning, rain, snow, and level 6 or stronger wind.
- Before installation, check the unit to ensure it is free of any transport or handling damage, which could affect insulation integrity or safety clearances. Choose the installation location carefully and adhere to specified cooling requirements. Unauthorized removal of necessary protections, improper use, incorrect installation, and operation may lead to serious safety and shock hazards or equipment damage.
- Do not install the equipment in adverse environmental conditions such as in close proximity to flammable or explosive substances; in a corrosive environment; where there is exposure to extremely high or low temperatures; or where humidity is high.
- Do not use the equipment when the safety devices do not work or are disabled.
- Use personal protective equipment, including gloves and eye protection during the installation.
- Inform the manufacturer about non-standard installation conditions.
- Do not use the equipment if any operating anomalies are found.
- All repairs should be carried out using only approved spare parts, which must be installed in accordance with their intended use and by a licensed contractor or authorized Fox ESS service representative.

### 3. Introduction

#### 3.1 Product Introduction

Smart Logger-A (hereinafter referred to as “logger”) supports collecting data, controlling power and converting protocol for inverters and other PV equipment in the PV plant. The device is also integrated with communication gateway and plant operation & management function. The device featuring flexible networking and auxiliary maintenance is easy to operate.

#### 3.2 Basic Features

- Supports RS485, CAN, 4G, Ethernet and WLAN communication.
- Supports collecting data from smart energy meter, meteo station, inverter and other equipments.
- Supports setting batch inverter parameter and upgrading software.
- Supports remote desktop function, which reduces maintenance costs.
- Supports sending grid control instruction and controlling power factor.
- Supports local real-time monitoring, unnecessary to connect to the internet.
- Supports searching and allocating inverter address automatically.
- Embeds with web operation interface, supports setting the device via web and Fox Cloud.

#### 3.3 Appearance

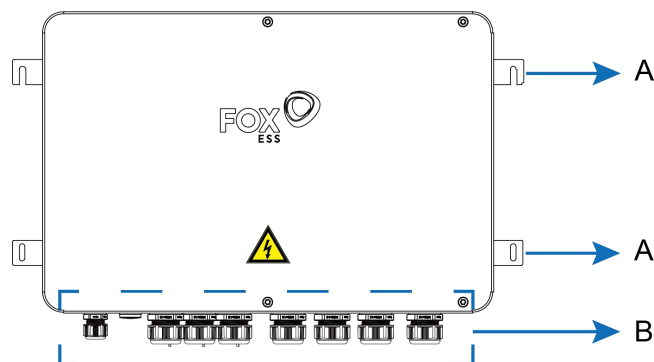

Item	Description
A	Mounting Ear
B	Waterproof Terminal

### 3.4 Dimensions

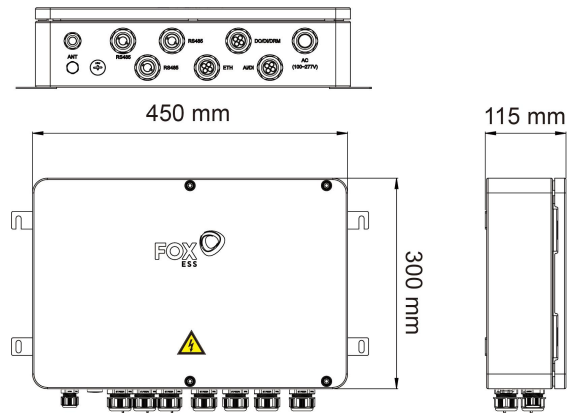

### 3.5 Application Scenario

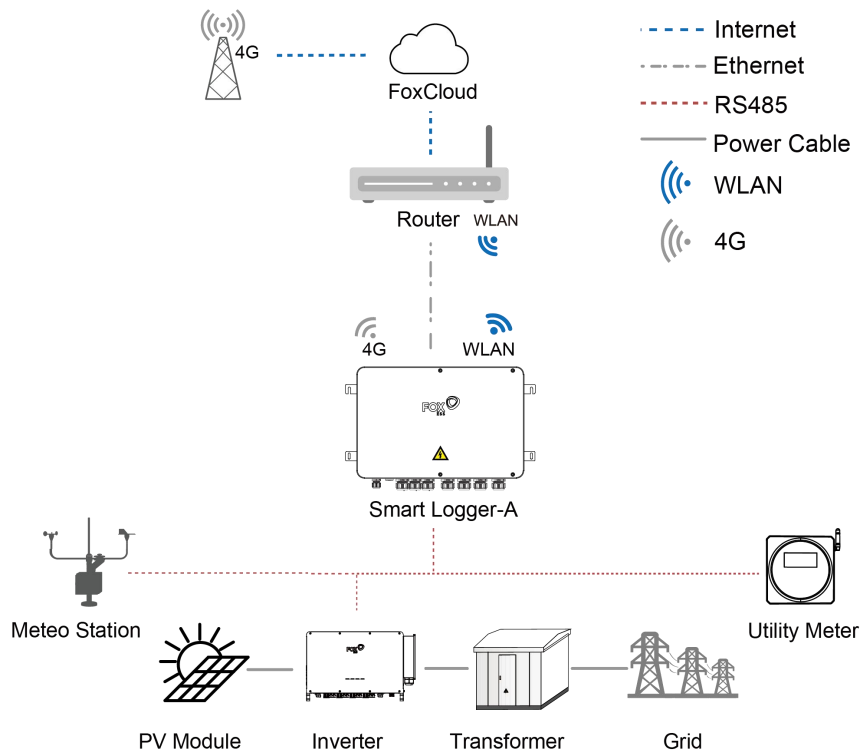

- The logger can be connected to FoxCloud via the router, WLAN or 4G network.
- The logger can be connected to smart energy meter (including utility meter), Meteo station and inverter in the PV power generation system via an RS485 bus.
- Users can set the logger via web and FoxCloud where remote on-line upgrading can be performed.
- The logger can transmit data to FoxCloud and forward background instructions to downstream devices.
- The logger is equipped with grid dispatching function, including active power control, reactive power regulation, etc.



## 4. Technical Parameters

MODEL	Smart Logger-A
<b>Communication</b>	
Max.Number of Inverters	30
RS485 Interface	6, Modbus RTU, Sunspec, 9600bps, 19200bps, 38400bps, 57600bps, 115200bps
CAN Interface	2
Ethernet	2, RJ45, 10M/100M
Digital Input	8
Digital Output	4, Relay, Normal Open
Analog Input	4, 4~20mA or 0~10VDC, support converting into Digital Input
4G (Optional)	"LTE-FDD: B1, B3, B5, B8 LTE-TDD: B34, B38, B39, B40, B41 WCDMA: B1, B8 TD-SCDMA: B34, B39EVDO/CDMA: BC0 GSM: 900MHz,1800MHz"
WiFi	802.11 b/g/n/ac HT20/40MHz 2.4GHz
Power Out	Voltage equals the value of DC Input, Max. 0.5A
<b>Indicator LED</b>	
LED	3 LEDs
<b>Power Supply</b>	
DC Input	10V~27V, Max. 1.25A
Power Consumption	Typ. 20W, Max. 30W
<b>Ambient Conditions</b>	
Operating Temperature	-30°C ~ 60°C
Storage Temperature	-40°C ~ 70°C
Relative Air Humidity	≤95 % (non-condensing)
Elevation	≤4000m
Protection Class	IP66
<b>Mechanical Parameters</b>	
Dimensions (W*H*D)	450mm*300mm*115mm
Weight	7kg
Mounting Type	Wall Mounted, Bracket Mounted, Outdoor or Indoor

## 5. Installation

### 5.1 Check for Physical Damage

- Check all safety signs and warning labels on devices. The safety signs and warning labels must be clearly visible and cannot be removed or covered before the device is decommissioned.
- Ensure the device model is correct. Make sure the logger has not been damaged during transportation. If there is any visible damage, such as cracks, please contact your dealer immediately.

### 5.2 Packing List

Open the package and take out the product, please check the accessories first. The packing list is shown below:

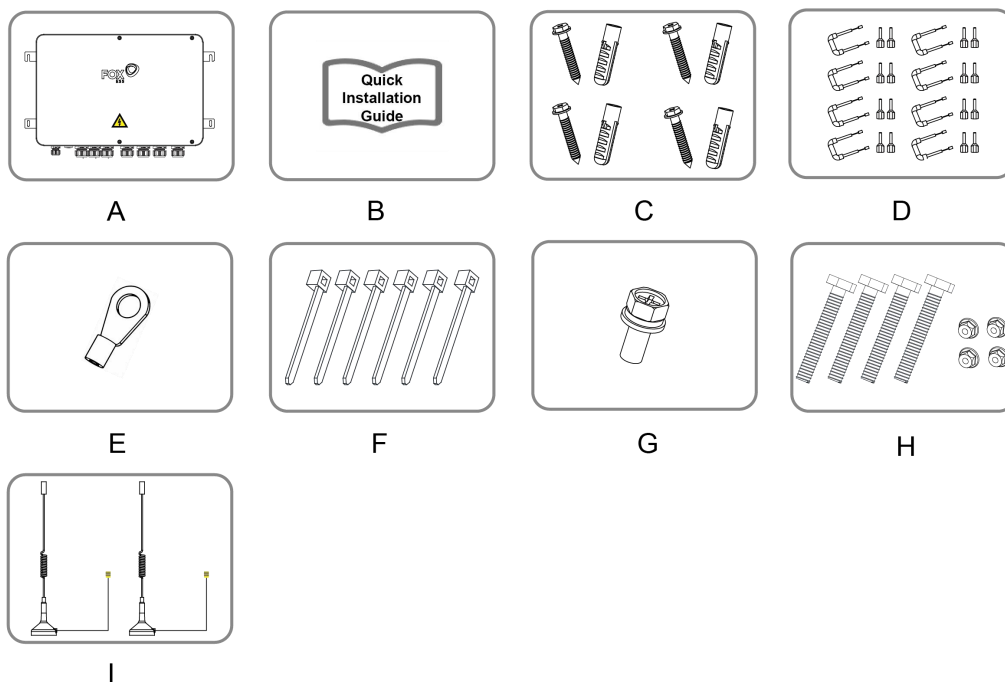

Object	Quantity	Description	Object	Quantity	Description
A	1	Smart Logger-A	F	6	Cable Tie
B	1	Quick Installation Guide	G	1	Screw M4*10
C	4, 4	Self-tapping Screw M6*40, Expansion Tube $\Phi$ 8*40	H	4, 4	Hexagon Bolt M6*45, Flange Nut M6
D	8	Terminal Resistor	I	2	Antenna
E	1	OT Terminal			

### 5.3 Storage

If the device is not to be installed immediately after receiving, please store it properly according to the following requirements.

- The device should be stored in its original packing case and placed in a well-ventilated, dry and tidy room.
- The storage carrier should be able to carry the weight of the device.
- The storage environment should be well ventilated, dry and without any accumulated water.
- Ambient temperature: -40°C to +70°C; relative humidity: 0~95%, no condensation.
- Take precautions to protect the device against damage due to harsh environment such as shock cooling, shock heating, and collision.
- Regularly inspect the device, usually at least once a week. Check the package intactness and replace it immediately when necessary.
- After long-time storage, thoroughly check the device and ensure it is undamaged before installation. If necessary, install the device only after it has been tested by qualified personnel.

	<p><b>Warning!</b></p> <ul style="list-style-type: none"> <li>• The device must be packed during storage.</li> <li>• Never store the device outdoors or in an environment directly exposed to sunlight.</li> <li>• No tilting or stacking.</li> </ul>
---	---

#### 5.4 Mounting

- Installation Precaution

Make sure the installation location complies with the following conditions:

- Not in direct sunlight.
- Not in areas where highly flammable materials are stored.
- Not in potential explosive areas.
- Not in the cool air directly.
- Not near the television antenna or antenna cable.
- Not higher than altitude of about 4000m above sea level.
- Not in environment of precipitation or humidity (>95%).
- Take anti-moisture and anti-corrosion measures.
- Under good ventilation condition.
- The ambient temperature in the range of -30°C to +60°C.
- The slope of the wall should be within  $\pm 5^\circ$ .
- The wall hanging the device should meet conditions below:
  1. Solid brick/concrete, or strength equivalent mounting surface;
  2. The device must be supported or strengthened if the wall's strength isn't enough (such as wooden wall, the wall covered by thick layer of decoration).
- Avoid direct sunlight, rain exposure, snow laying up during installation and operation.
- Ensure that enough space is reserved around the device. The installation location should be 500mm above the ground surface, and maintenance clearance of at least 500mm should be reserved.
- Space Requirement

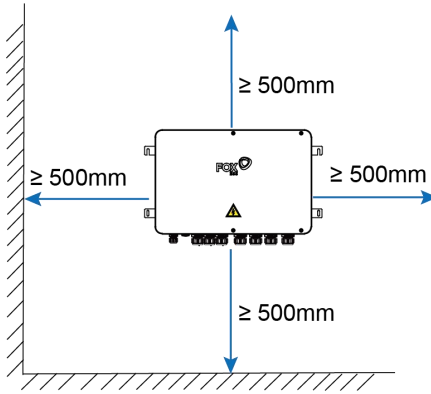

	<p><b>Note!</b></p>
<p>When there are external devices (such as Meteo Station) connected to the logger, users should add corresponding communication SPD according to onsite condition.</p>	

• Installation Steps

Tools required for installation include, but not limited to, the following recommended tools. If necessary, use other auxiliary tools on the spot.



Safety Goggles

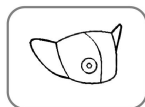

Dust Mask



Insulating Gloves



Tape

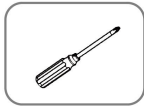

Phillips-Head Screwdriver



Flat-Head Screwdriver



Wire Stripper



Electric Drill

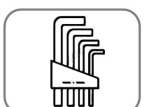

Hex Wrench Set



Adjustable Wrench



Marker

**Step 1: Wall Installation or Bracket Installation**

The logger can be installed in the wall-mounting manner or bracket-mounting manner. Users can select one installation method according to onsite condition.

**Method 1: Wall Installation**

Place the device on the wall, adjust the angle and mark drilling positions with marker.

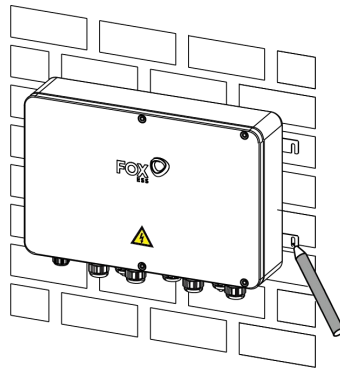

- Drill holes with an electric drill, clear holes and insert 4 expansion tubes into holes, and fix them with a rubber hammer.

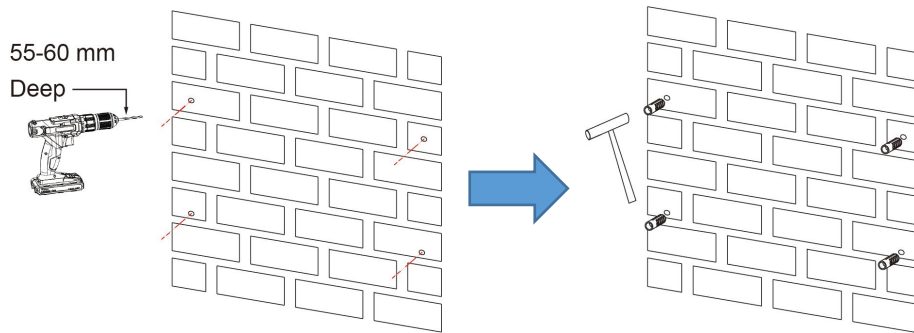

- Fix the device with 4 self-tapping screws.

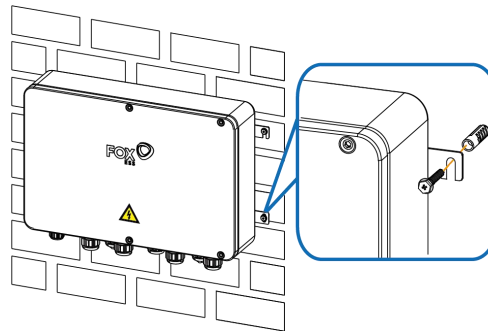

### Method 2: Guide Rail-Mounting

- Install the device on the bracket and ensure that lugs of the device are properly matched with slots of the bracket. Fix the device with 4 screws.

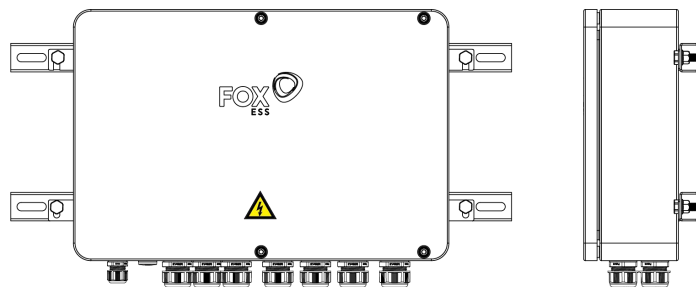

### Step 2: Antenna Installation

- Unscrew the device cover with a hex wrench.

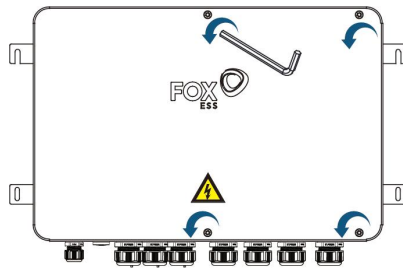

- Connect the antenna cable with the USB WiFi adapter and plug the USB WiFi adapter into the terminal.

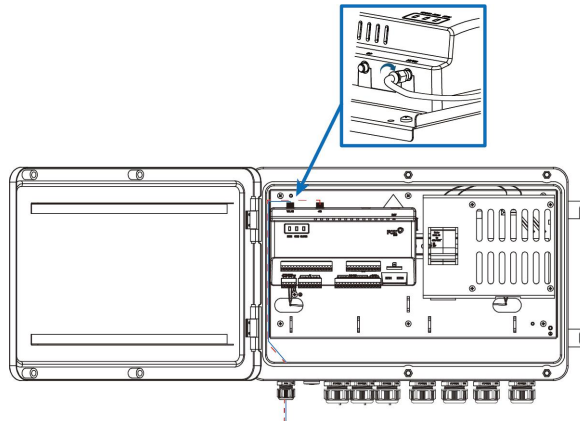

- Secure the antenna base on metal surface outside the device or the container (if the logger is installed in a container).

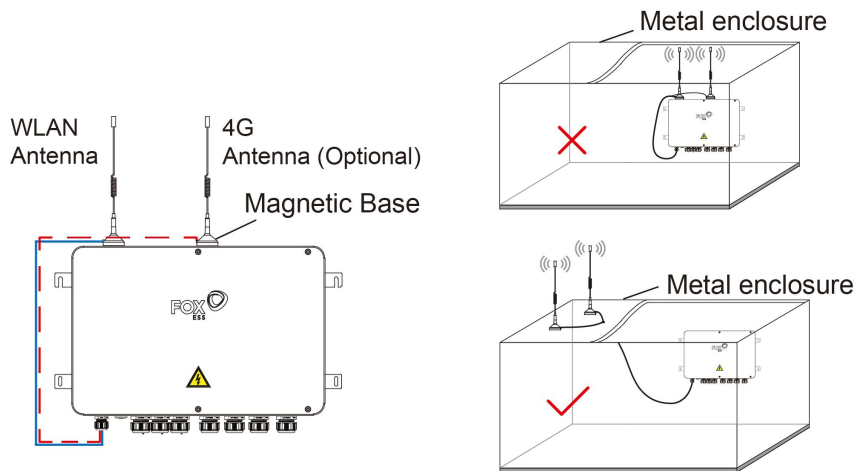

**Note!**

The distance between WLAN antenna and 4G antenna should be more than 150 mm (if both are installed on the logger or container).

## 6. Electrical Connection

### 6.1 Safety Instructions

	<p><b>Note!</b></p> <ul style="list-style-type: none"> <li>• Before electrical connections, please make sure that the product is not damaged. Otherwise, it may cause danger!</li> <li>• Before electrical connections, please make sure that the product switch and all switches connected to the product are set to "OFF", otherwise electric shock may occur!</li> <li>• Incorrect cable connection may cause device damage or even personal injury.</li> <li>• All cables used shall comply with the requirements of local laws and regulations, and must be intact, well insulated, appropriately dimensioned and firmly connected.</li> </ul>
---	---

### 6.2 Port and Indicator Introduction

External wiring terminals are located at the top and bottom of the logger.

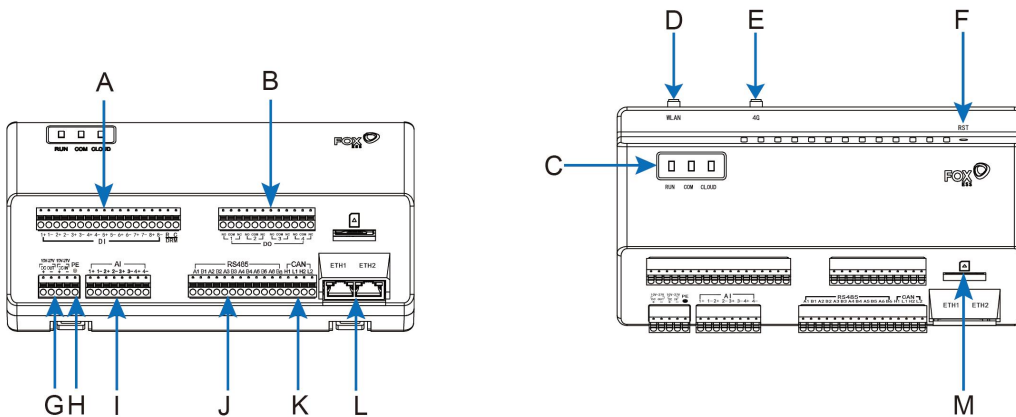

Object	Label	Description	Object	Label	Description
A	DI/DRM	Digital Input/Demand Response Modes Function	H	PE	Grounding
B	DO	Digital Output	I	AI	Analog Input
C	RUN/ COM/ CLOUD	Indicators	J	RS485	RS485 Communication Port
D	WLAN	WLAN Antenna	K	CAN	CAN Communication Port
E	4G	4G Antenna	L	ETH	Ethernet Port
F	RST	Reset Button	M		SIM Card Slot
G	DC OUT/IN (10~27V)	Power Output/ Power Input			

Indicator	Status	Description
RUN ( Operational Status)	Off	No Power Supply
	Steady on (Green)	Running Normally
	Slow Flash (Red)	Device Alarms
COM (Sub-device Communication Status)	Off	Sub-devices Communication Failure
	Steady on	Sub-device Communication Normal
	Slow Flash	Part of the Sub-devices Communication Failure
CLOUD (Platform Communication Status)	Off	No WiFi/4G/Ethernet or Fault
	Steady on	WiFi/4G/Ethernet Running Normally
	Slow Flash	Connecting with WiFi/4G/Ethernet
	Quick Flash	Data Transmission

### 6.3 Connect to PV Devices

Devices in the PV system that can be connected to the logger include the inverter, Meteo Station, Smart Energy Meter, etc.

#### 6.3.1 Connect to Inverter

Communication cable specification:

Cable	Type	Recommended Cross-section
AC Cable	Shield Twisted Pair	0.5mm <sup>2</sup> ~1.0mm <sup>2</sup>



**Note!**

- Please refer to the inverter's user manual for inverter's RS485 connection information.
- Connect the inverter to terminal RS485A2 and RS485B2 of the logger via cable.
- The RS485 communication cable must be shielded twisted pair with the shielding layer single-point grounded.
- When a multi-core multi-strand copper wire cable is used, crimp an appropriate euro style terminal at the communication cable head and then connect it to the RS485 port of the logger.
- This manual uses the R 100 and H3-Pro model as examples to illustrate the RS485 connection between the logger and inverter.
- A resistor should be inserted into inverter excepting H3-Pro in RS485 connection.

##### 6.3.1.1 Connect to R100

- Lead the RS485 communication cable from the inverter to the wiring area of the logger.
- Strip the cable jacket and insulation layer with a wire stripper by about 18mm and 10mm to 12mm respectively.



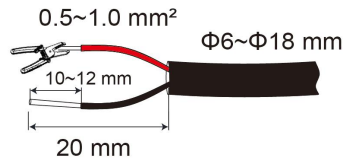

- Connect the striped cable to the RS485 ports of the logger and connect the logger to the inverter via cable.

#### Connect to single inverter

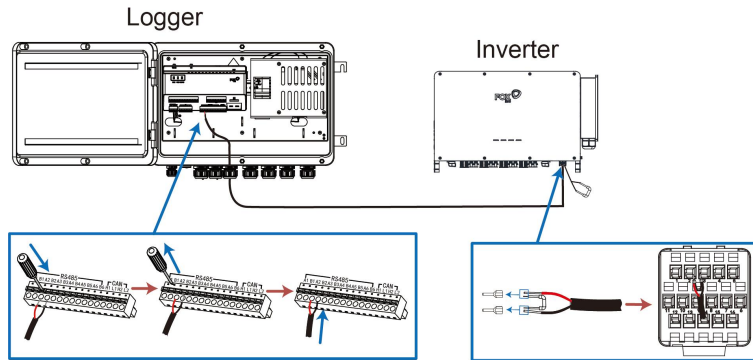

#### Connect to multiple inverters

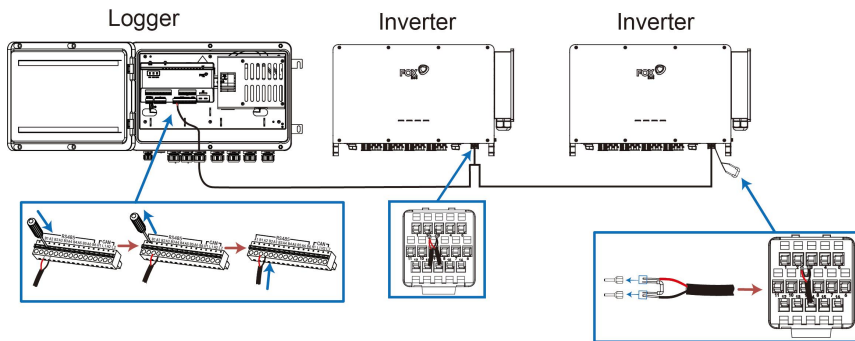

#### Note!

- In the process of connecting logger to multiple R100 inverters, please plug the cable into every inverter's terminal 2 and terminal 3.
- A 120Ω resistor should be inserted into the inverter at the tail end.

#### 6.3.1.2 Connect to H3-Pro

- Lead the RS485 communication cable from the inverter to the wiring area of the logger.
- Strip the cable jacket and insulation layer with a wire stripper by about 18mm and 10mm to 12mm respectively.

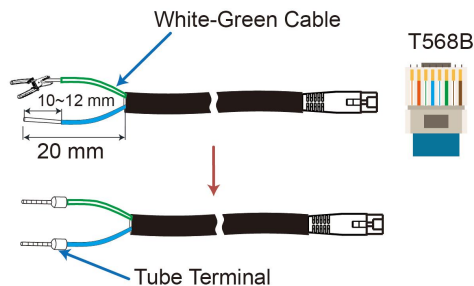



**Note!**

The H3-Pro RS485 cable shall be equipped with ENY 0512 tube terminals or other Euro terminals of the same size.

- Connect the striped cable to the RS485 ports of the logger and connect the logger to the inverter via cable.

**Connect to single inverter**

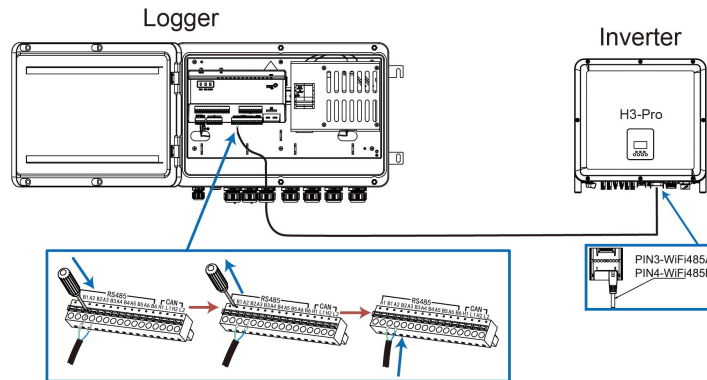

**Connect to multiple inverters**

In the process of connecting logger to multiple H3-Pro inverters, please plug the cable to the 1 or 2 RS485 terminal of the inverter at the tail end. And then push 4 white DIP switches to "ON" position (from down to up) by a suitable tweezer as shown in the diagram below.

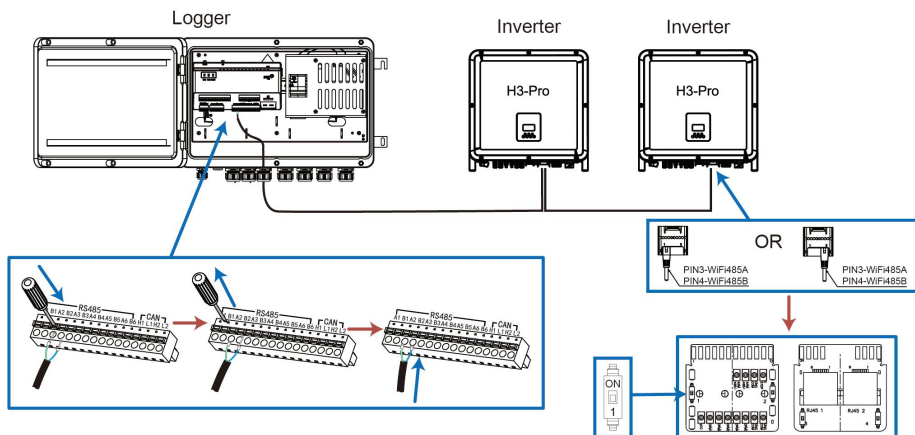

**6.3.2 Connect to Multiple Devices**

Multiple inverters can be connected to the logger in RS485 daisy chain manner. If more than 15 inverters are connected on the RS485 bus, it is recommended to connect a 120Ω terminal resistor in parallel on the RS485A and RS485B lines at the tail end of the bus.

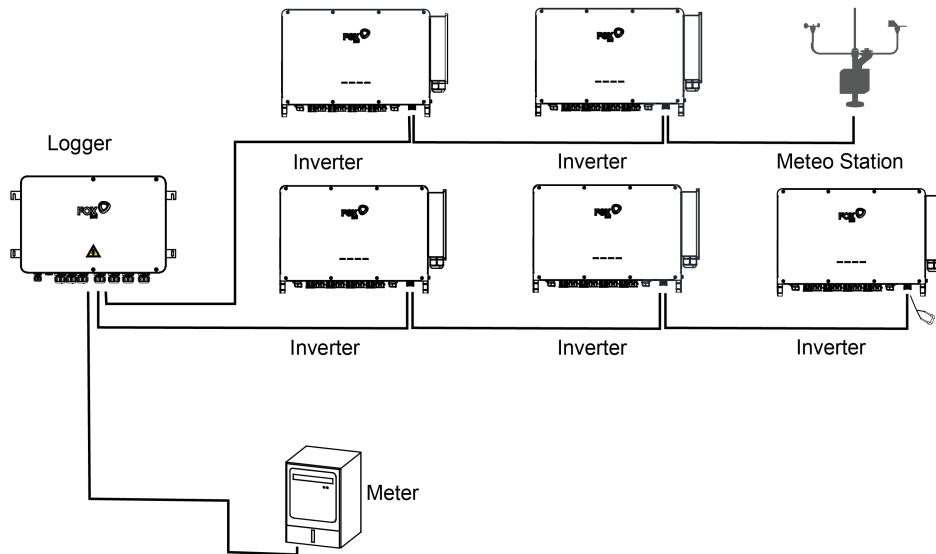

**Note!**

With an outdoor device connected to the logger, it is recommended to connect an SPD to protect the logger from lightning damage.

- The logger allows for 6 inputs of RS485 buses and 30 devices at most.
- When the number of device types is less than or equal to the number of RS485 ports of the logger, it is recommended to connect different types of devices to different RS485 ports separately.
- The addresses of devices on each RS485 bus must be different from one another and within the address range set for the logger. Otherwise, communication error will occur.
- Serial port parameters of each device on the RS485 bus should be consistent with those of the logger. The serial port parameters include baud rate, data bit, stop bit, and check bit.

**6.3.3 Connect to Smart Energy Meter**

It is recommended to use the CHNT meter DT(S)SU666 whose communication protocol complies with Modbus protocol. The logger can be connected to the meter through RS485 port or Ethernet port.

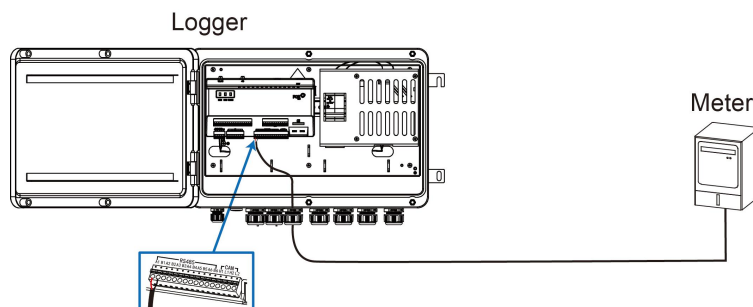

**Note!**

- Connect the meter to terminal RS485A1 and terminal RS485B1 of the logger via cable.
- All devices on each RS485 bus support the same communication protocol.

**6.3.4 Connect to Meteo Station**

Meteo Station includes standard Meteo Station and discrete Meteo Station. The discrete Meteo Station consists of several sensors. It is recommended to use Meteo Station complying with Modbus

protocol. Meteo Station can be connected to the logger through RS485 port or AI port.

#### Method 1: RS485 Connection

Connect the communication cable led from the Meteo Station to the RS485 port of the logger.

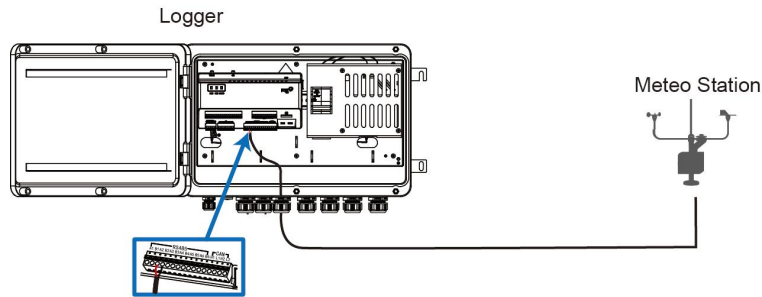

If multiple inverters are connected to the logger together with the Meteo Station, the Meteo Station should be connected on the very end of the daisy chain.

#### Method 2: AI Connection

Connect the communication cable led from the Meteo Station to the AI port of the logger.

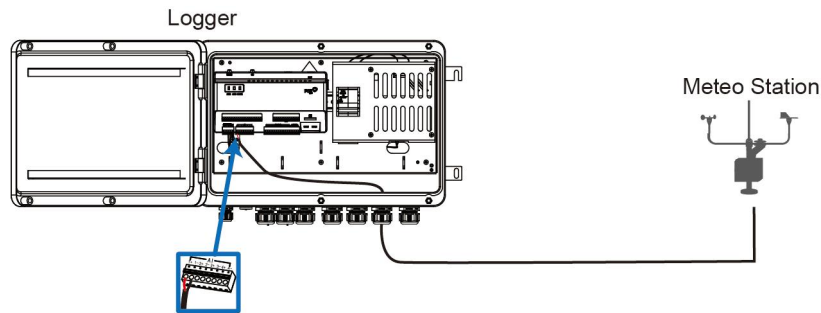

### 6.4 Connect to Background

The logger can be connected to the background of the PV system via the network port, and the communication protocol is standard Modbus TCP. As a slave device, the logger can be accessed by multiple backgrounds and communicate by using the standard protocol. The logger can be connected to multiple monitoring background systems via the Ethernet switch or router, or it may be connected to the single monitoring background system via the network cable.

For example, the logger is connected to the background system via the Ethernet switch, and the wiring steps are as follows:

Step 1: Prepare an Ethernet cable of suitable length.

Step 2: Insert one end of the cable into the port of the Ethernet switch and the other end to the "ETH" port of the logger.

Step 3: Set IP address of the ETH port to be within the same network segment as that of the background monitoring system.

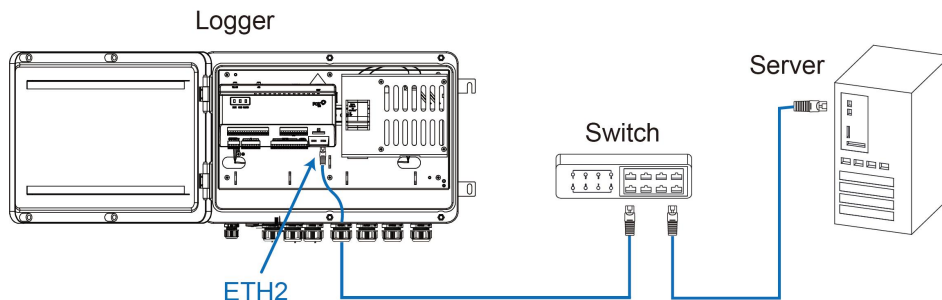



**Note!**

- Default configuration of the ETH2: DHCP.
- Insert the cable into the ETH2 port of the logger.

**6.5 Connect to Micro-SIM**

Support Micro-SIM.

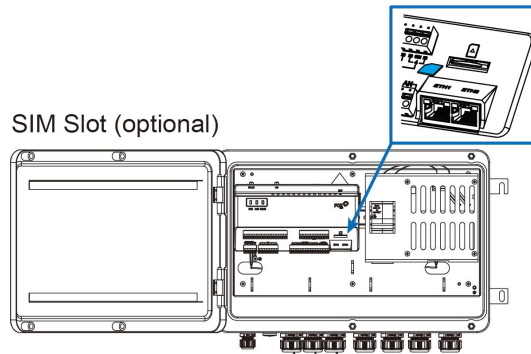

**6.6 Cable Routing Requirements**

- Cables used in the system generally include power cables and communication cables.
- The communication cable needs to be routed away from the power cable, and the cables need to form a right angle at the intersection. The communication cable needs to be as short as possible and keeps a distance from the power cable.
- Power cables and communication cables should be routed in different cable trenches to avoid long-distance parallel cable routing of power cables and other cables, thereby reducing electromagnetic interference due to output voltage transient.
- The distance between the power cable and communication cable should be greater than 200mm. When the cables meet with each other, the cross angle should be 90°, and the distance can be reduced accordingly.

The following table shows the recommended minimum distances between parallel shielded communication cables and power cables.

Parallel Cable Length (m)	Min. Distance (m)
200	0.3
300	0.5
500	1.2

The communication cables should be routed as closely to the ground surface or supports (such as support beam, steel channel) as possible.

## 7. Commissioning

### 7.1 Inspection before Commissioning

No.	Inspection Item	Result
1	All cables are intact, well-insulated, and appropriately dimensioned.	
2	All Cables are connected correctly and firmly	
3	The polarity of the power supply cable is correct. The grounding cable is reliably grounded.	

### 7.2 Commissioning Steps

No.	Step	Result
1	Inspection before commissioning.	
2	Power on the logger.	
3	Check whether the indicator of the logger flash normally or not.	
4	Connect the debugging PC to the WiFi AP of the logger (default IP address of the logger: 192.168.1.136).	
5	Make sure the communication cable connecting the device and the logger is firmly in place, and connect the DC circuit breaker of the inverter to ensure the inverter is supplied with power.	
6	Configure related parameters according to Chapter 8 "Web Interface".	
7	Connect to FoxCloud via 4G, WiFi (configure ssid and password) and Ethernet (the cable shall plug into ETH2 and router).	
8	Enable address recognition and connect with inverter. The platform is equipped with meteo station, meter and other devices.	

## 8. Web Interface

### 8.1 Running Requirements

Item	Parameter
Browser	IE 11 or above, Chrome 65 or above, and Safari 11 or above
Min.resolution	1024*768

### 8.2 Login Steps

Users can log into the logger via WiFi AP.

Step 1: Connect the logger to the PC via WiFi AP.

	<b>Note!</b> Please select "FOX-EMS-XXXX" ("XXXX" is the the last four digits of the SN code. ) and enter password "12345678".
---	---

Step 2: Enter the IP address 192.168.1.136 in the PC address bar to enter the general user login interface.

Step 3: Enter the user name "admin" and password "admin" and click "Login".

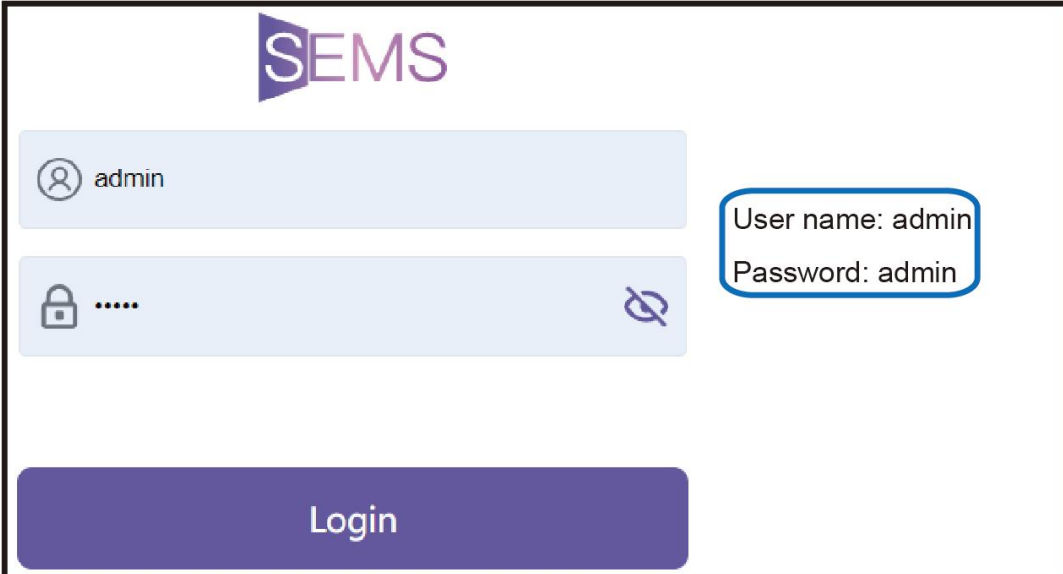

### 8.3 Configuration Steps

Users can configure the logger via the Ethernet or WiFi.

#### Method 1: Ethernet

Go to "Lan configuration", select "NetWork" as "Ethernet". Default "Type" is "DHCP".

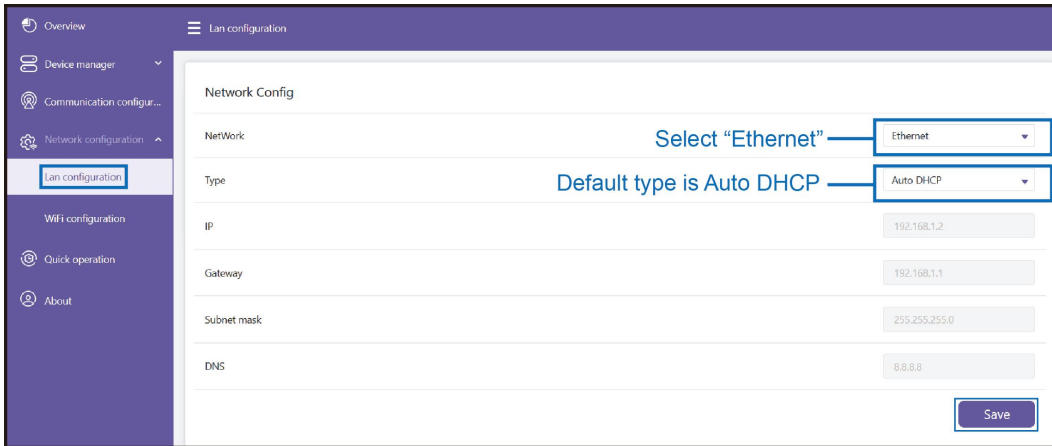

## Method 2: WiFi

Go to “WiFi configuration”, enter “SSID” and “Password”.

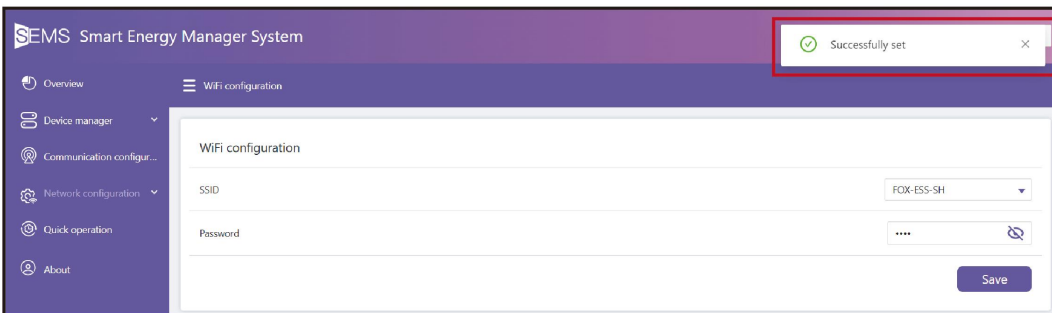
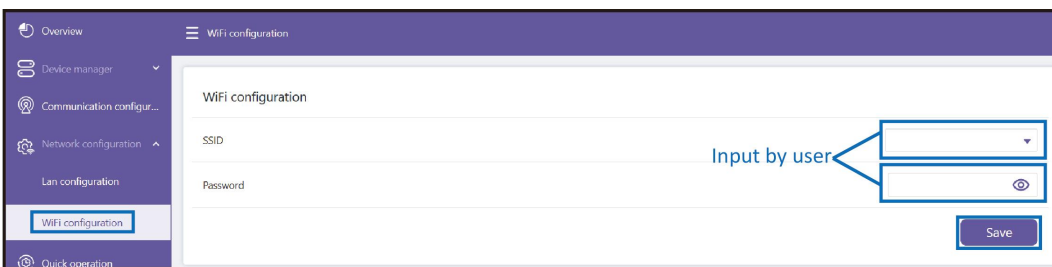

## 8.4 Create Site

Users can create site.

Step 1: Enter the IP address “www.maitian-yun.com” in the PC address bar to enter the general user login interface.

Step 2: Sign in with your installer/agent’s account. Go to “EMS” and click the “configuration” icon.

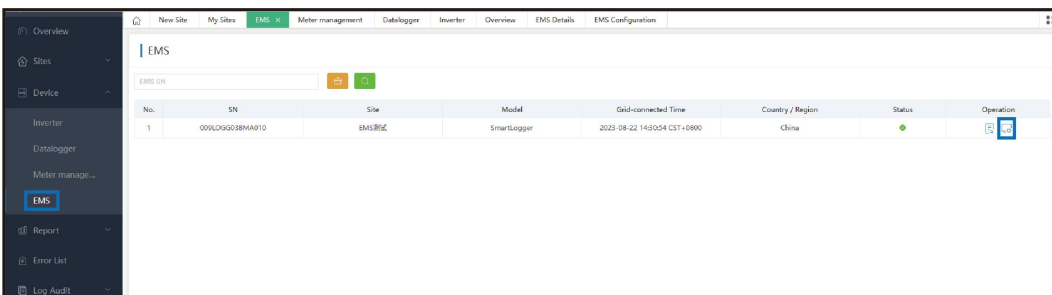

Step 3: Configure sub-device’s address.



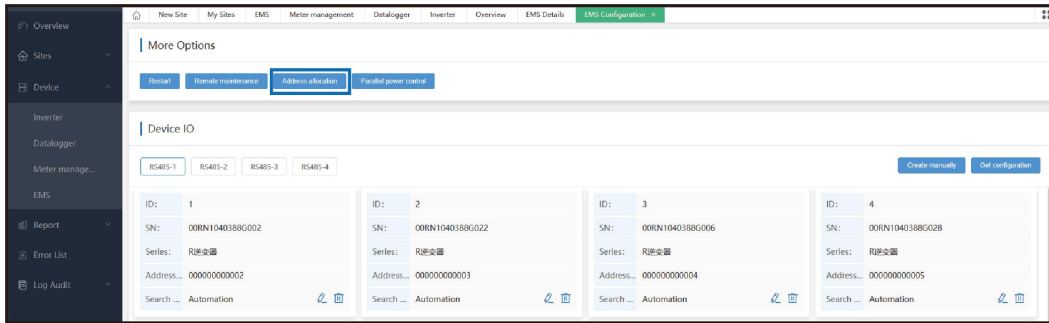

## Method 1: Configure address automatically.

Go to “Address Allocation”.

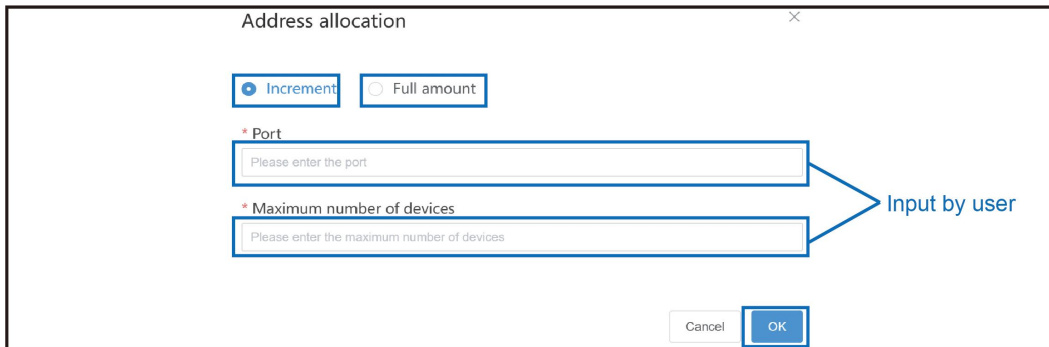

Select “Increment” mode or “Full amount” mode and enter information required.



	<p><b>Note!</b></p> <ul style="list-style-type: none"><li>• Increment: Distribute addresses to new sub devices.</li><li>• Full amount: Reset all sub devices' addresses and distribute addresses to new sub devices.</li></ul>
---	--

## Method 1: Configure address manually.

Go to “Create manually”.

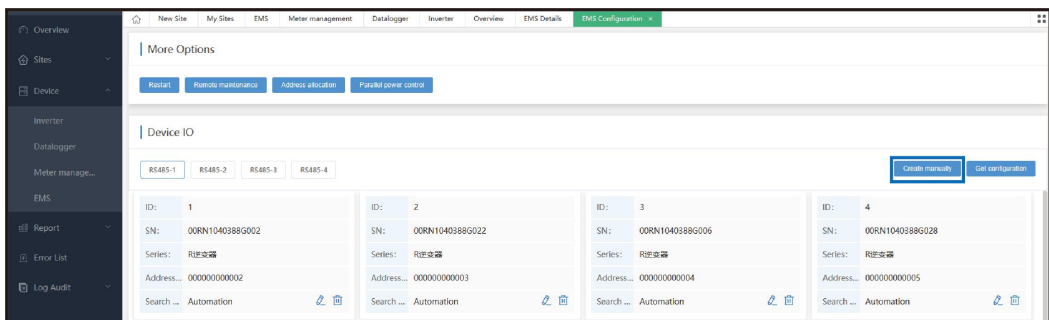

Enter information required.

Input by user

Step 4: Create new site.

Go to "New Site" and enter information required.

Input by user



Success

Status	Site	Country / ...	City	Postcode	Registrat...	System Size	PV Size	Power Generating...	Today Yield(kWh)	Commission Time	Operation
No Data											

## 9. Grid Dispatch



### Note!

Only installation personnel with professional expertise can perform operations in this chapter.

### 9.1 Function Description

The logger not only serves as a communication management device of a single PV array/plant, but also has the power regulation function. Multiple regulation manners can meet different regulation requirements. The logger can regulate the power output of the inverter, and the regulation mainly includes active power control and reactive power control.

The logger can control device power output according to the local preset instructions. In addition, it can receive dispatch instructions via the remote communication, AI, and dry contact.

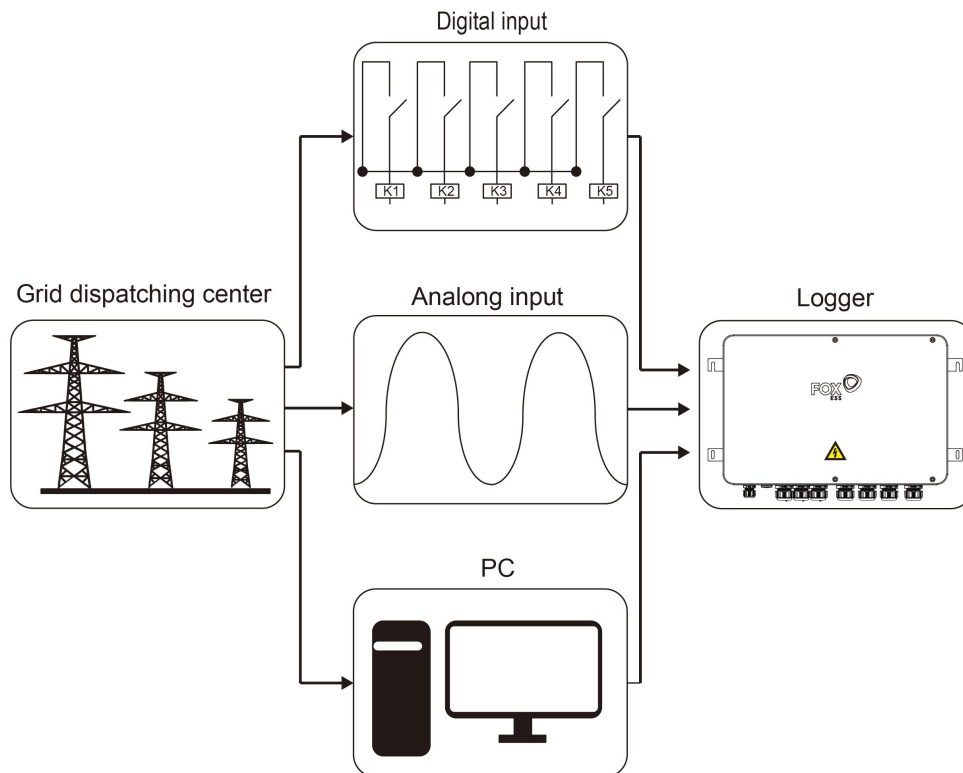

The logger supports closed-loop power regulation. The regulation accuracy and real-time performance can be further improved by adding the Smart Energy Meter.

The logger supports fast instruction transfer channels (ms-level processing delay) while ensuring that the dispatching instructions are correctly transmitted to all inverters.



### Note!

- The corresponding power dispatching function is available only when the inverter supports active power control, power factor control, and reactive power regulation.
- For details, please refer to the inverter user manual or consult the local retailers.

### 9.2 Interface Description

The logger is equipped with digital control ports and analog control ports for receiving digital instructions and analog instructions sent from the grid dispatching center.

### 9.2.1 Digital Control Interface

Digital control interface is located at the bottom of the logger.

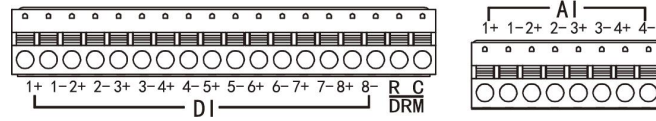

#### Wireless receiver controller (Ripple Control Receiver)

Wiring between the logger and the Ripple Control Receiver is as follows:

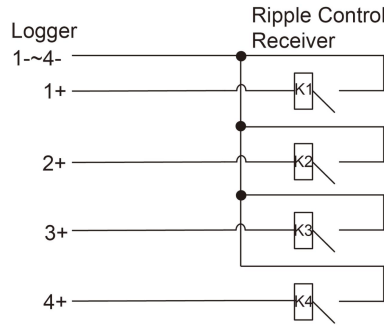

In some regions, the grid company uses the Ripple Control Receiver to convert the grid dispatching signal and send it in a dry contact manner. In this case, the plant needs to receive the grid dispatching signal in the dry contact communication way.

#### Reactive power dry contact

Wiring of the reactive power dry contact is shown in the figure below:

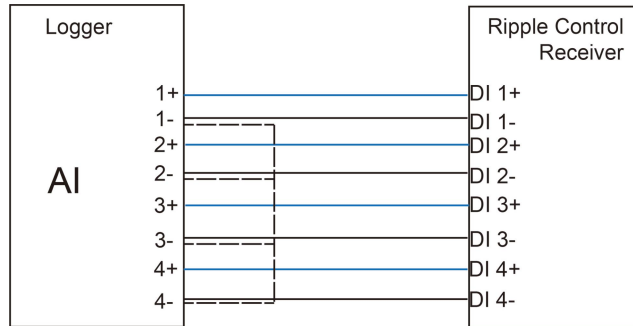

#### Active power dry contact

Wiring of the active power dry contact is shown in the figure below:

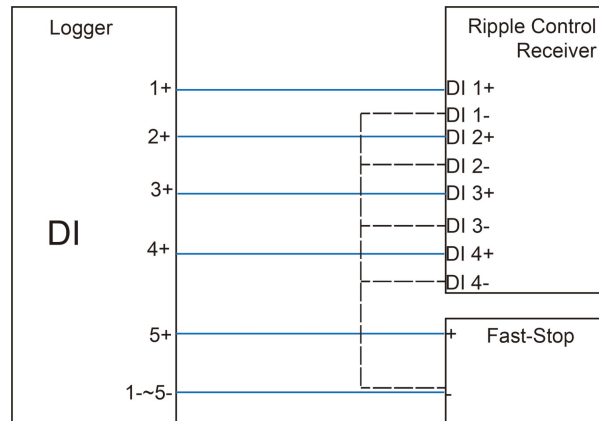

### 9.2.2 Analog Control Interface

The analog control interface is at the bottom of the logger, and a sum of 4 analog input ports are provided, as shown in the figure below:

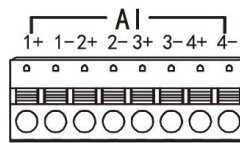

The logger supports 4 inputs of 4~20mA analog current or 4 inputs of 0~10V analog voltage.

### 9.2.3 DRM Control Interface

The DRM control interfaces are located at the bottom of the logger, as shown in the figure below.

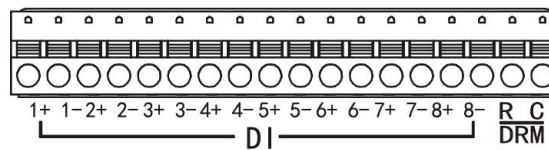

The DRM interfaces work together with DI1 to DI4 to achieve the DRM function.

Wiring between the logger and the DRED is as follows:

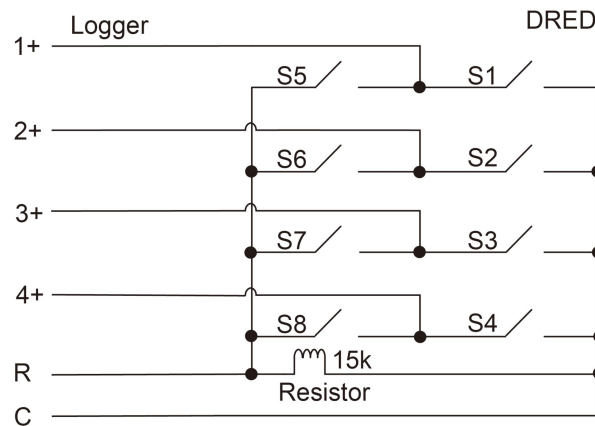

The DRM interfaces require that the logger can be connected to the DRED via the corresponding wiring terminal.

## 10. Maintenance

This section contains routine and periodic maintenance measures about the logger.

	<p><b>Note!</b></p> <ul style="list-style-type: none"> <li>• Unauthorized modification or use of parts not sold or recommended by Fox ESS may result in fires and electric shocks.</li> <li>• To avoid the risk of electric shock, do not perform any other maintenance operations beyond this manual. If necessary, contact Fox ESS for maintenance. Otherwise, the losses caused are not covered by the warranty.</li> <li>• If a fault occurs, only restart the device after the fault is cleared. Otherwise, the fault may expand, and the device may be damaged.</li> </ul>
---	--

### 10.1 Safety Instructions

Observe the following instructions through the maintenance or service process to ensure personnel safety.

- Disconnect the logger from all external connections and internal power supplies.
- Ensure the logger will not be inadvertently connected.
- Ensure the logger is voltage free with a multimeter.
- Connect necessary grounding cables.
- Cover the electrical components with insulation cloth during operation.

### 10.2 Routine Maintenance

#### A. Safety Check

A safety check should be performed at least every 12 months by a qualified technician who has adequate training, knowledge and practical experience to perform these tests. The data should be recorded in an equipment log. If the logger is not functioning properly or fails any of the tests, the logger has to be repaired. For safety check details, refer to Chapter 2 of this manual.

#### B. Maintenance Checking List

During the process of using the logger, the responsible person shall examine and maintain the machine regularly. The required actions are as follows:

Checking List	Checking Method	Maintenance Period
System Cleaning	Check whether there are dust and other blockades at the air outlet and heat sink. If necessary, clean the air outlet and heat sink.	Once half a year to a year (Depending on ambient dust content)
Cable Inlet Holes	Check whether the cable inlet hole of the device is partially blocked or the gap is large. If yes, perform supplementary sealing.	Once a year
Electrical Connection	Check whether cables are loose. Check whether the cable is damaged, especially whether the part of the cable in contact with the metal shell is cut.	Once half a year to a year

Note: Only qualified individuals may perform these actions.

The copyright of this manual belongs to FOXESS CO., LTD. Any corporation or individual should not plagiarize, partially or fully copy (including software, etc.), and no reproduction or distribution of it in any form or by any means is permitted.

All rights reserved.

FOXESS CO., LTD.

Add: No. 939, Jinhai Third Road, New Airport Industry Area, Longwan District, Wenzhou,  
Zhejiang Province, China

Tel: 0510-68092998

[WWW.FOX-ESS.COM](http://WWW.FOX-ESS.COM)